

STEREO POWER AMPLIFIER

M-45

SERVICE MANUAL

FRONT PANEL

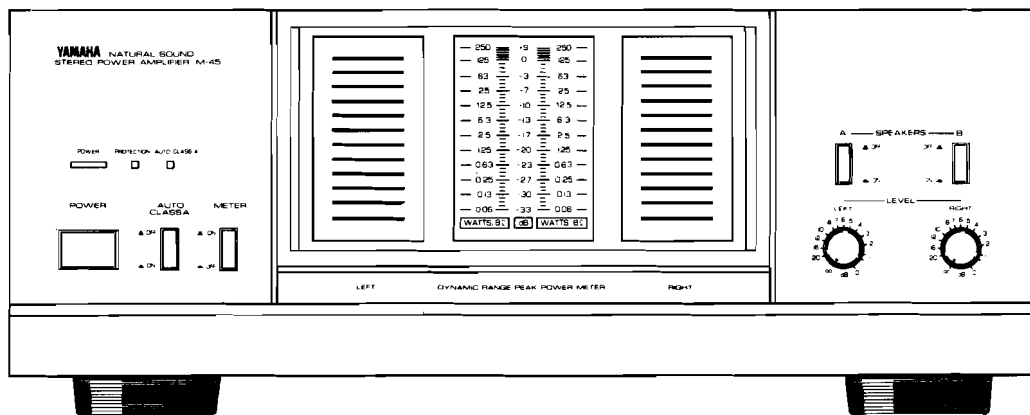

IMPORTANT NOTICE

This manual has been provided for the use of authorized Yamaha Retailers and their service personnel. It has been assumed that basic service procedures inherent to the industry, and more specifically Yamaha Products, are already known and understood by the users, and have therefore not been restated.

WARNING: Failure to follow appropriate service and safety procedures when servicing this product may result in personal injury, destruction of expensive components and failure of the product to perform as specified. For these reasons, we advise all Yamaha product owners that all service required should be performed by an authorized Yamaha Retailer or the appointed service representative.

IMPORTANT: The presentation or sale of this manual to any individual or firm does not constitute authorization, certification, recognition of any applicable technical capabilities, or establish a principle-agent relationship of any form.

The data provided is believed to be accurate and applicable to the unit(s) indicated on the cover. The research, engineering, and service departments of Yamaha are continually striving to improve Yamaha products. Modifications are, therefore, inevitable and specifications are subject to change without notice or obligation to retrofit. Should any discrepancy appear to exist, please contact the distributor's Service Division.

WARNING: Static discharges can destroy expensive components. Discharge any static electricity your body may have accumulated by grounding yourself to the ground buss in the unit (heavy gauge black wires connect to this buss).

IMPORTANT: Turn the unit OFF during disassembly and parts replacement. Recheck all work before you apply power to the unit.

CONTENTS

TO SERVICE PERSONNEL	1	ADJUSTMENTS	5
SPECIFICATION	1	ADJUSTMENT POINTS	6
DIMENSIONS	1	WIRING	7
REAR PANELS	2	PRINTED CIRCUIT BOARD (Pattern Side) . .	8~11
INTERNAL VIEW	3	SCHEMATIC DIAGRAM	12
DISASSEMBLY PROCEDURE	3	IC BLOCK DIAGRAM	13
BLOCK DIAGRAM	4	PARTS LIST	14~20



TO SERVICE PERSONNEL

- Critical Components Information.**
Components having special characteristics are marked Δ and must be replaced with parts having specifications equal to those originally installed.
- Leakage Current Measurement (For 120V Model Only).**
When service has been completed, it is imperative that you verify that all exposed conductive surfaces are properly insulated from supply circuits.
 - Meter impedance should be equivalent to 1500 ohm shunted by 0.15 μ F.
 - Leakage current must not exceed 0.5mA.
 - Be sure to test for leakage with the AC plug in both polarities.

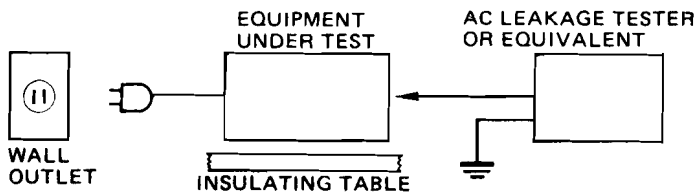

■ SPECIFICATIONS

Minimum RMS Output Power Channel (Auto class A 5W/8Ω)	
20Hz ~ 20kHz 0.003% THD 8 ohms	125W
0.007% 6 ohms	150W
0.02% 4 ohms	180W
Dynamic Power Per Channel	
8 ohms	170W
6 ohms	210W
4 ohms	285W
2 ohms	390W
DIN Standard Output Power Per Channel	
1kHz (1% THD 4 ohms)	195W (A.G.B.)
Dynamic Headroom	
8 ohms	1.34dB (R.U.C.)
6 ohms	1.46dB (R.U.C.)
4 ohms	2.12dB (R.U.C.)
IEC Power	
1kHz (0.01% THD) 8 ohms	135W (A.G.B.)
6 ohms	170W (A.G.B.)
Power Band Width	
(0.03% THD 62.5W) 8 ohms	10Hz ~ 60kHz
Dampina Factor	
1kHz 8 ohms	70
Input Sensitivity/Impedance	
MAIN IN	1.14V/20k Ω
Frequency Response	
MAIN IN	+0, -0.3dB
Total Harmonic Distortion	
AUX/TAPE/TUNER (8 Ω)	
MAIN IN (62.5W/8 Ω)	0.002%
Intermodulation Distortion	
MAIN IN	125 W 8 Ω 0.003%
Signal to Noise Ratio (IHF-A-Network)	
MAIN IN (Shorted)	123dB
MAIN IN (5.1kohms terminated)	119dB
Residual Noise (IHF-A-Network)	
	16 μ V
Channel Separation (Vol -30dB)	
1kHz/10kHz	89dB/70dB
Power Supply	
AC110/120/220/24	AC120V, 60Hz (U.C.)
	60/50Hz (R)
Power Consumption	
	500W/660VA (U.C.)
	500W (R)
	650W (A.G.B.)
AC Outlet Unswitched	
	200W (max)
Dimensions (W x H x D)	
	435 x 165 x 420 mm
	(17-1/8") x (6-1/2") x (16-1/2")
Weight	
	12.5kg
	(27 lbs) (8 oz)

*Specifications subject to change without notice.

- (U) U.S.A. model
- (C) Canadian model
- (A) Australian model
- (G) European model
- (B) British model
- (R) Others model

■ DIMENSIONS

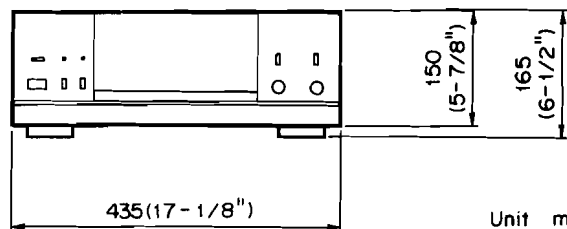
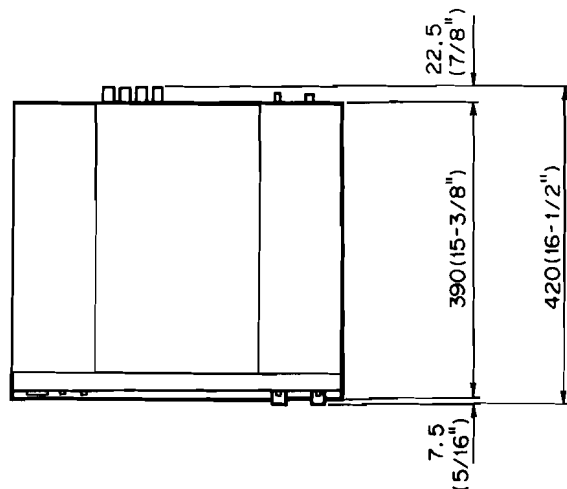

Unit mm (inch)

■ REAR PANELS

● U.S.A. & Canadian models

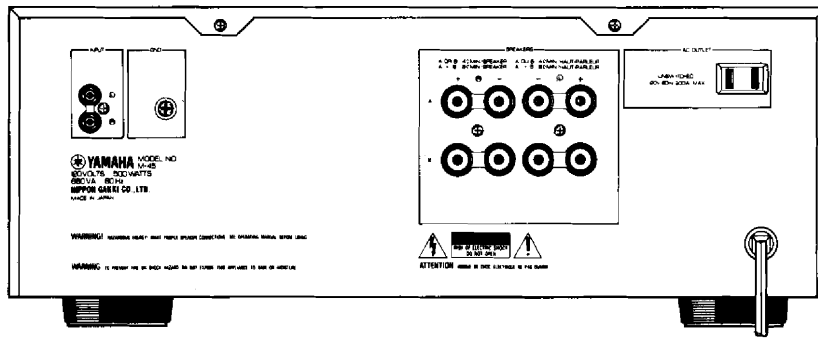

● European & British models

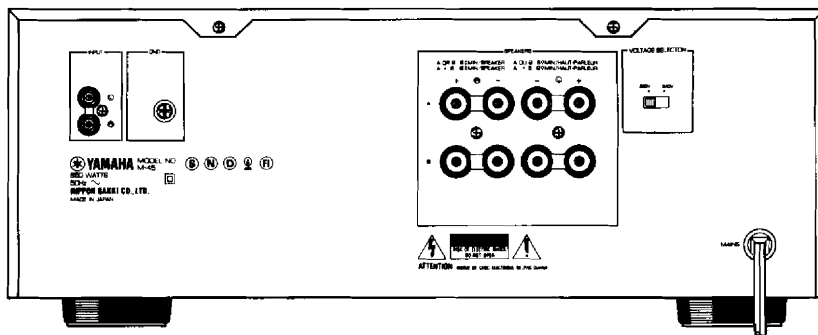

● Australian model

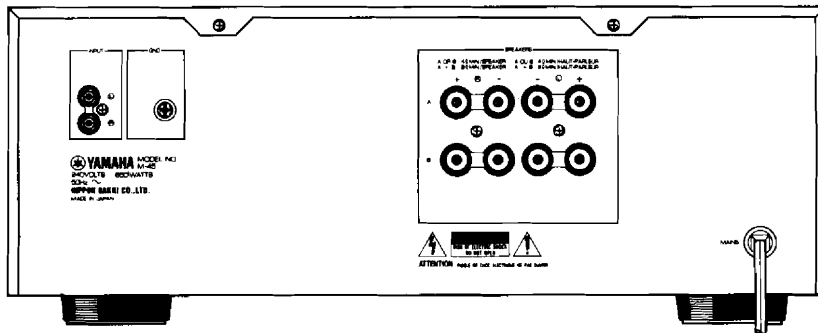

● Others model

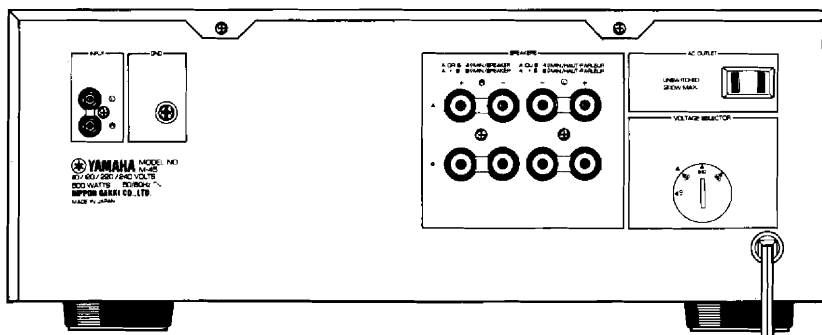

■ INTERNAL VIEW

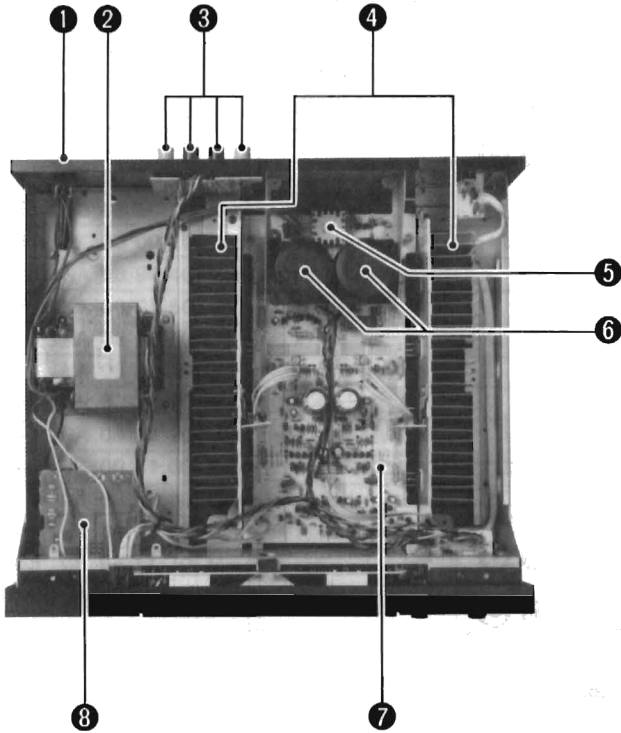

- ① AC OUTLET
- ② POWER TRANSFORMER
- ③ SPEAKERS TERMINAL
- ④ HEAT SINK
- ⑤ DIODE BRIDGE: D5FB20
- ⑥ ELECTROLYTIC CAP
- ⑦ MAIN CIRCUIT BOARD
- ⑧ METER CIRCUIT BOARD

■ DISASSEMBLY PROCEDURES

1. **Removal of Top Cover.**
 - a. Remove 6 screws (①) in Fig. 1. and slide the Top Cover back.
2. **Removal of Rear Panel.**
 - a. Remove 15 screws (②) in Fig. 1.
3. **Removal of Front Panel.**
 - a. Remove 4 screws (③) in Fig. 1.
 - b. Remove 5 screws (④) LED Circuit Board, and 15 screw screws Remove of the LED unit.
4. **Removal of Bottom Cover.**
 - a. Remove 11 screws (⑤) in Fig. 1. and Heat seat Removal.

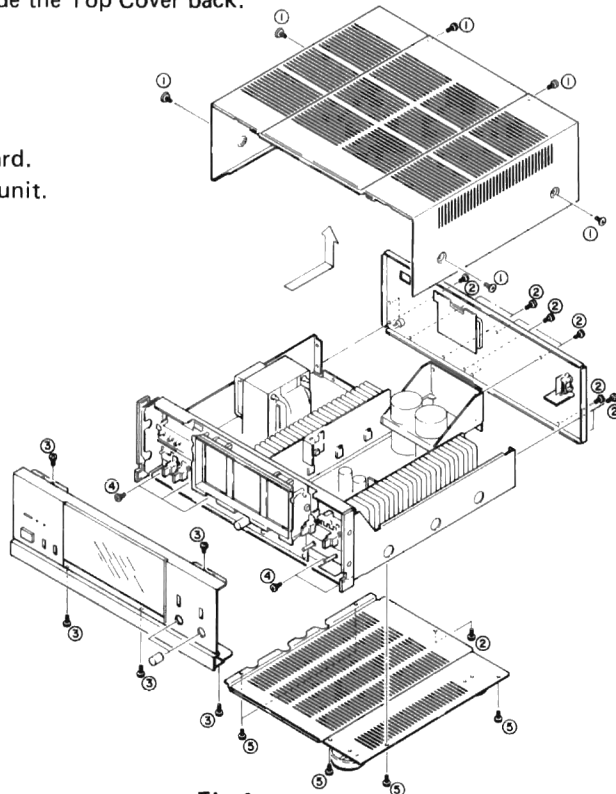

Fig.1

■ ADJUSTMENTS

Item	Condition or procedure	Check point	Adjustment	Direction	Equipment	Remarks
Idling adjustment	Before starting, leave M-45 about two minutes with: (a) AC POWER SWITCH – ON (b) AUTO CLASS-A SWITCH – OFF (c) NO signal input	*Voltage across R155 – Lch R156 – Rch	VR103 VR104	Adjust to $5 \pm 1\text{mV}$	DC VM	*Any of the power transistor's emitter resistor 3P 0.22Ω L-ch: R155,157,159,161 R-ch: R156,158,160,162
Confirming AUTO CLASS-A function	Leave M-45 about one minutes after activating AUTO CLASS-A SWITCH. NO signal input.	Same as above	Same as above	The readings $60 \pm 30\text{mV}$	DC VM	
Meter level setting	1 (a) Amplifier load: NO load or 8Ω (b) Input signal freq.: 1kHz (c) Output level: 0.69V	–33dB level LED	VR303-(L) VR304-(R)	Adjust the control to the LED lights up point		
	2 Reduce the signal level to 0.65V output (–0.5dB)	Same as above		Confirm the 0dB LED fades out		
	3 Increase the output level to 31.6V	0dB level LED	VR301-(L) VR302-(R)	Adjust to the LED lights up point		
	4 Reduce the signal level to 29.8V output (–0.5dB)	Same as above		Confirm the 0dB level LED fades out		
	5 Remove the input signal	–33dB level LED		Confirm its fading out		

■ ADJUSTMENT POINTS

MAIN CIRCUIT BOARD

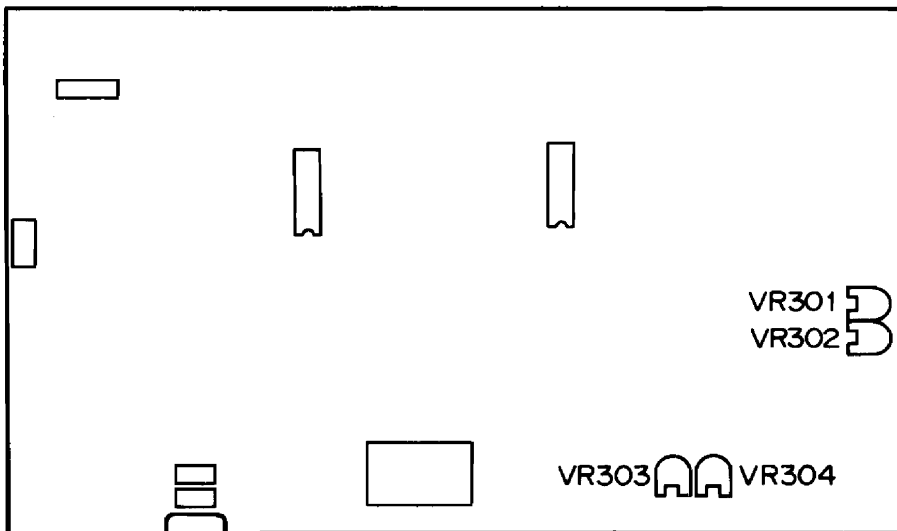
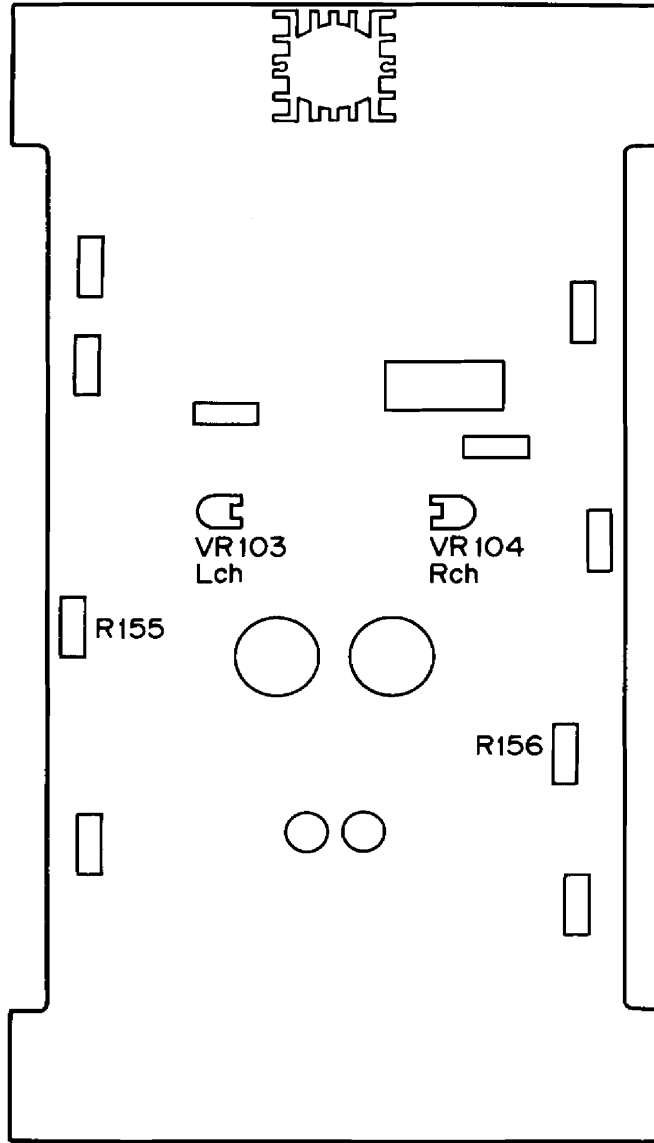

METER CIRCUIT BOARD

■ WIRING

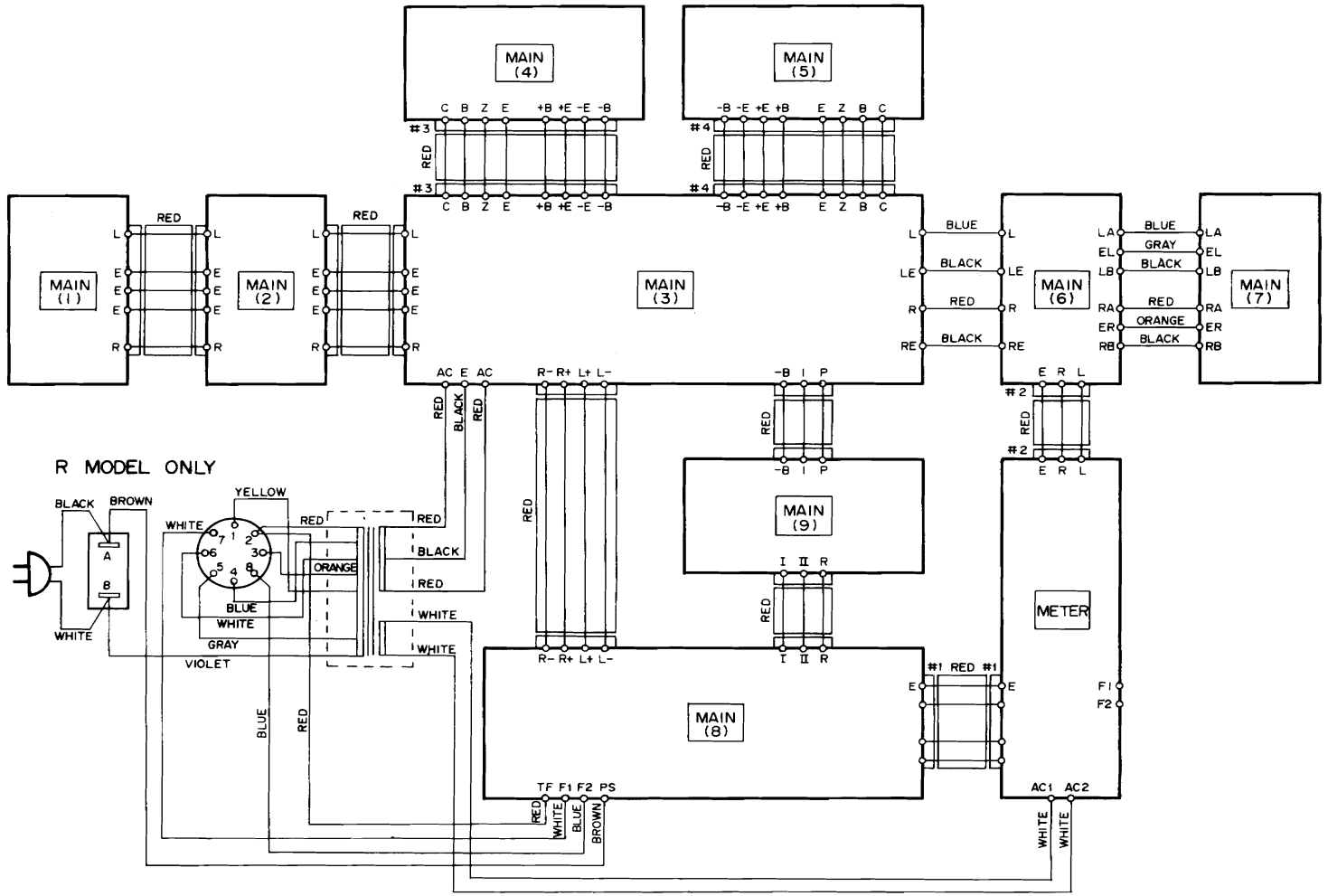

R MODEL ONLY

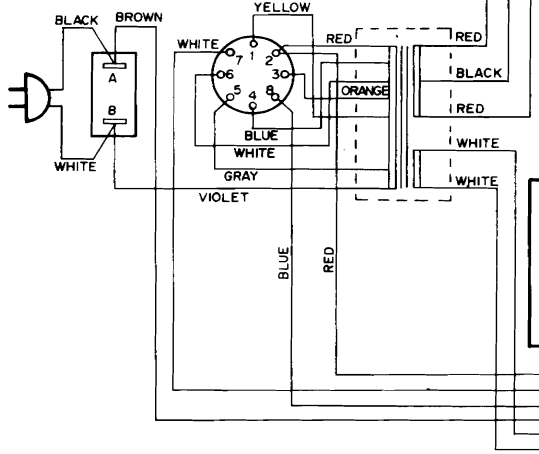

U, C MODELS ONLY

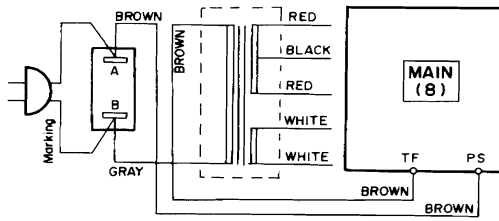

R MODEL LB201480

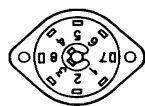

AC IN	CONNECT (Terminal No.)	
100V	5-4	2-1
120V	6-5	3-2
220V	7-1	8-4
240V	7-6	8-3

A MODEL ONLY

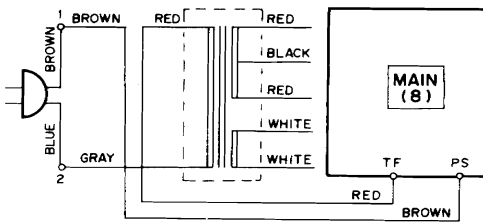

G, B MODELS ONLY

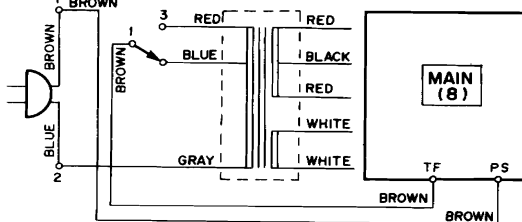

METER CIRCUIT BOARD

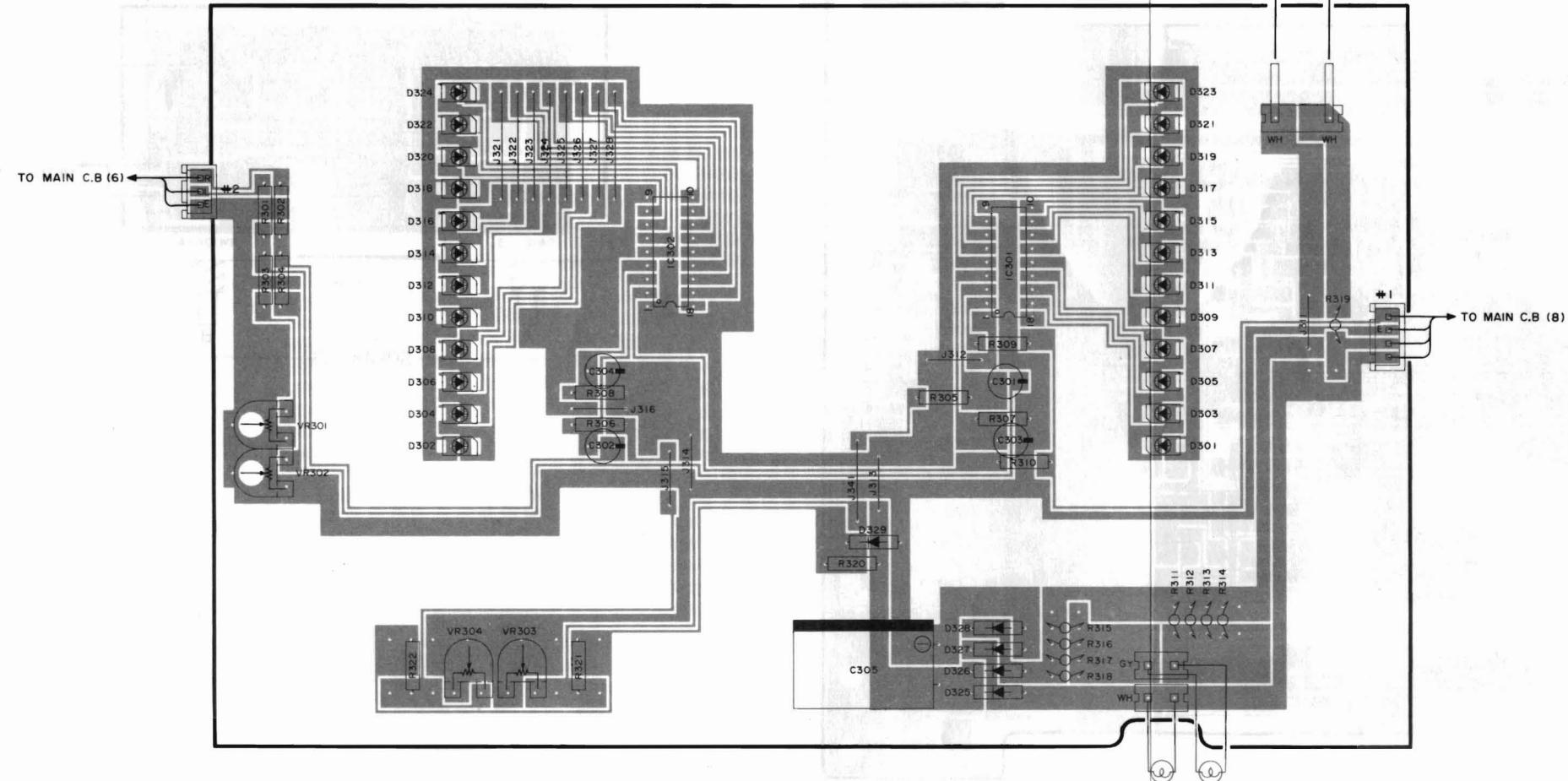

MAIN CIRCUIT BOARD (8)

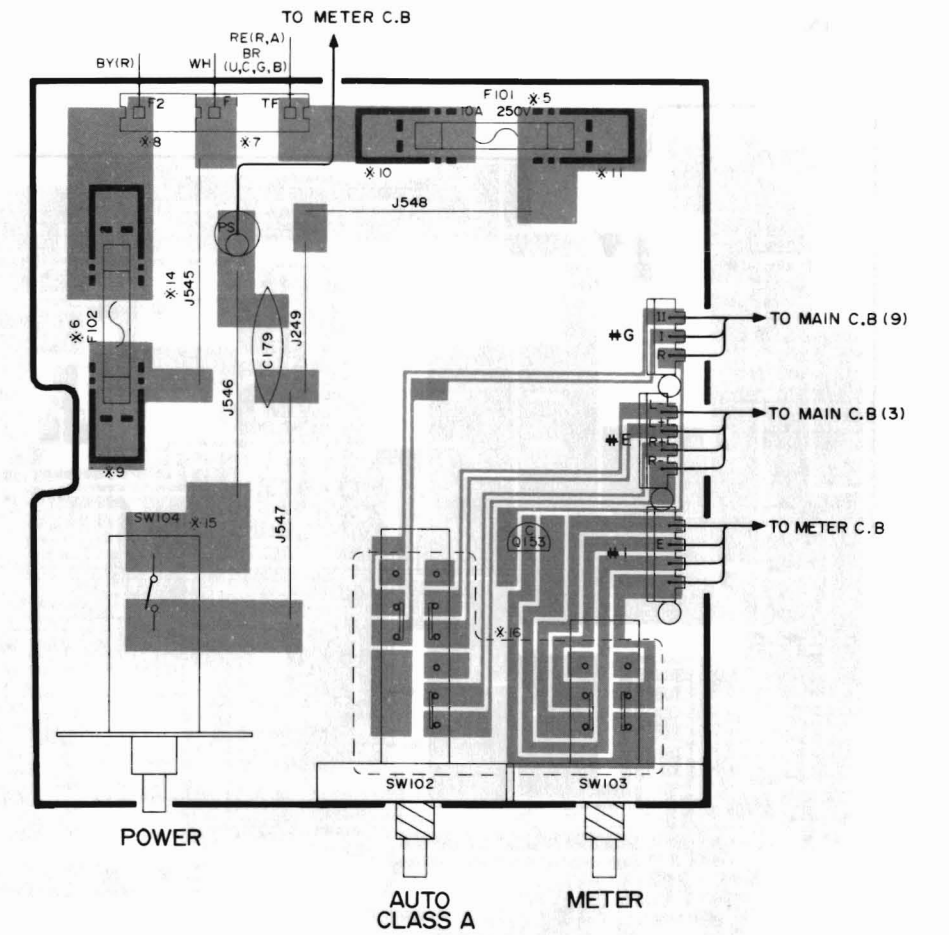

MAIN CIRCUIT BOARD (7)

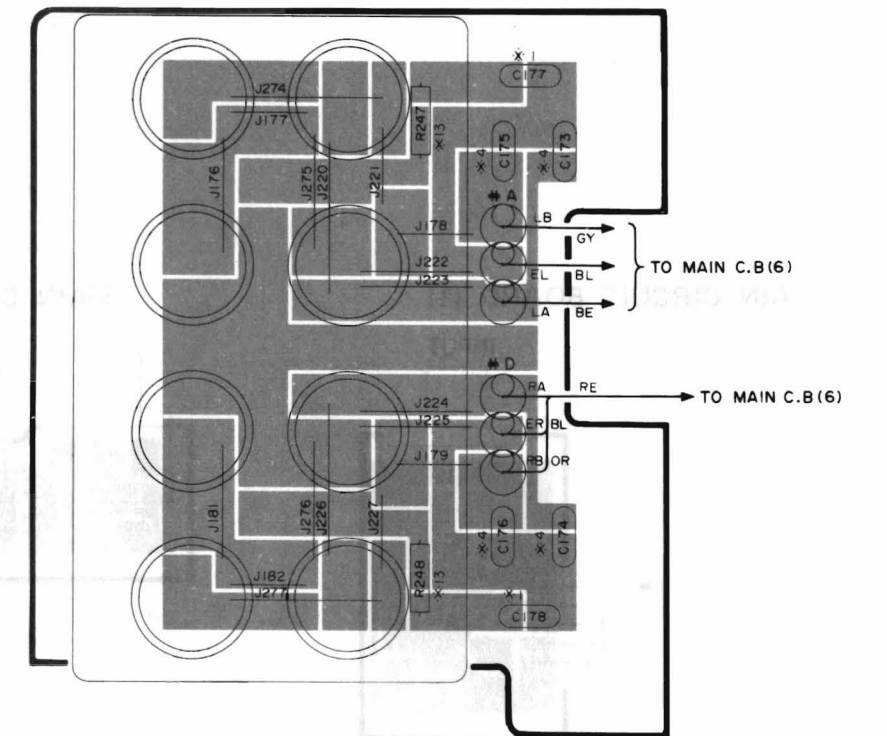

MAIN CIRCUIT BOARD (9)

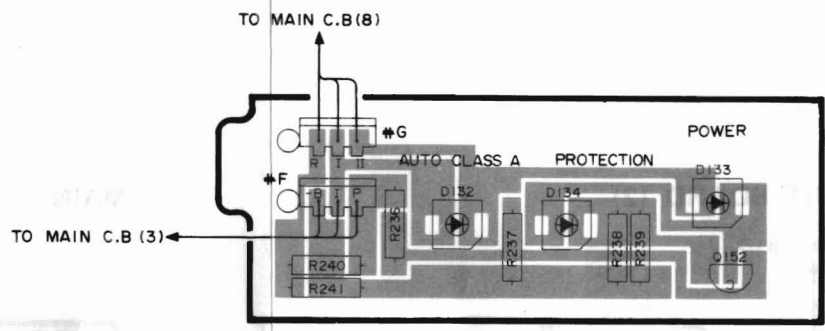

Note: * marked

*		R	U	A, G, B	C
1	C177, 178	OPEN	OPEN	0.01 (K)	OPEN
2	C167	0.1/250	0.1/250	OPEN	0.1/250
3	C168~170	OPEN	OPEN	0.1/250	OPEN
4	C173~176	OPEN	OPEN	2700P/100	OPEN
5	F101	10A 250V	10A 250V	T4A 250V	10A 250V
6	F102	T5A 250V	OPEN	OPEN	OPEN
7	LA002480		○	○	○
8	LA002490	○	/	/	/
9	LB201970	○	/	/	/
10	LB201970	○	○	/	○
11	LB201060	/	/	○	/
12	BB068370	/	/	○	/
13	R247~249	OPEN	OPEN	10	OPEN
14	J545	○	/	/	/
15	SW104	KA80352	KA80352	KA80352	KA80430
16	CA085260	/	/	/	○

■ SCHEMATIC DIAGRAM

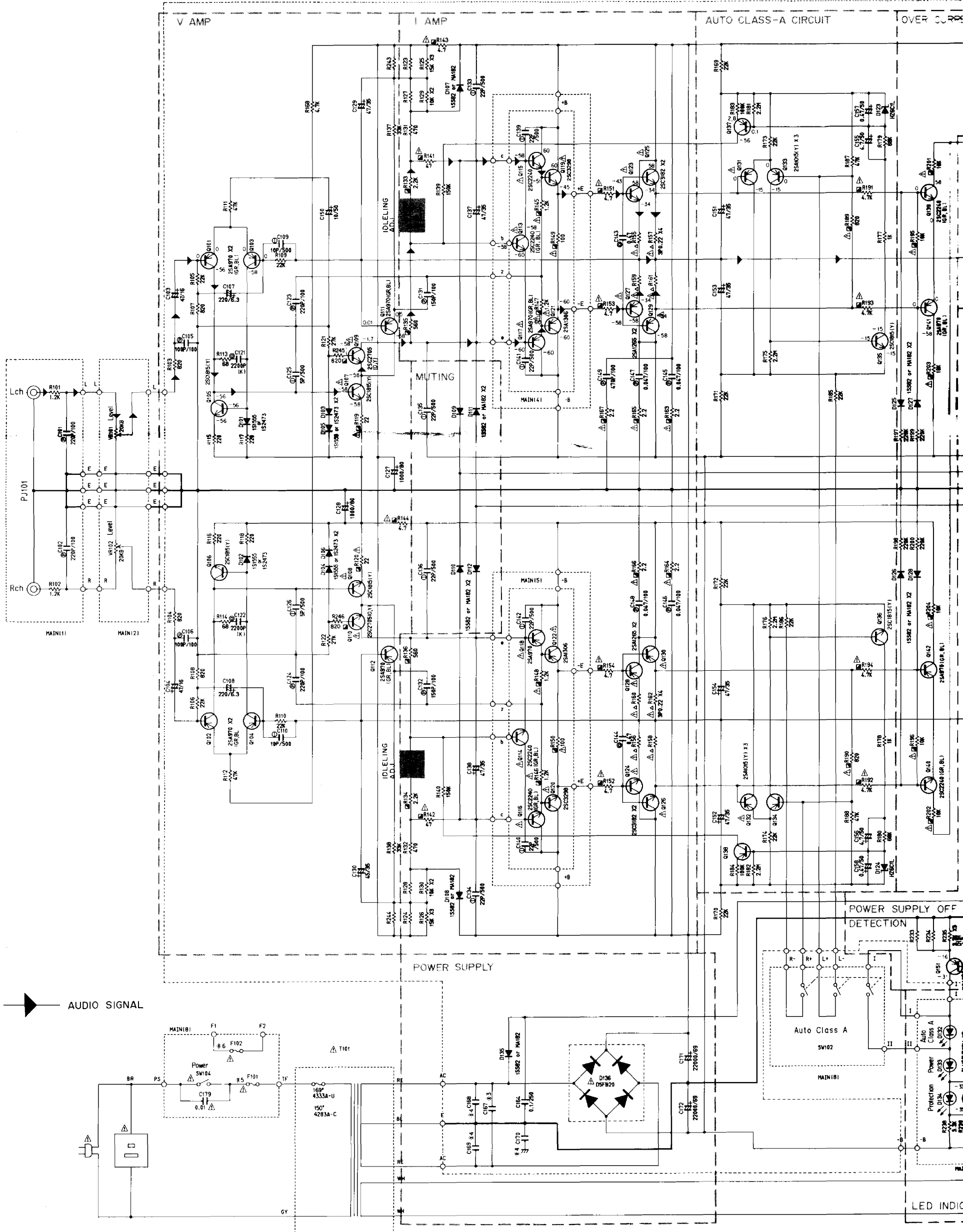

■ PIN CONNECTION DIAGRAM OF TRANSISTORS, DIODE AND ICS.

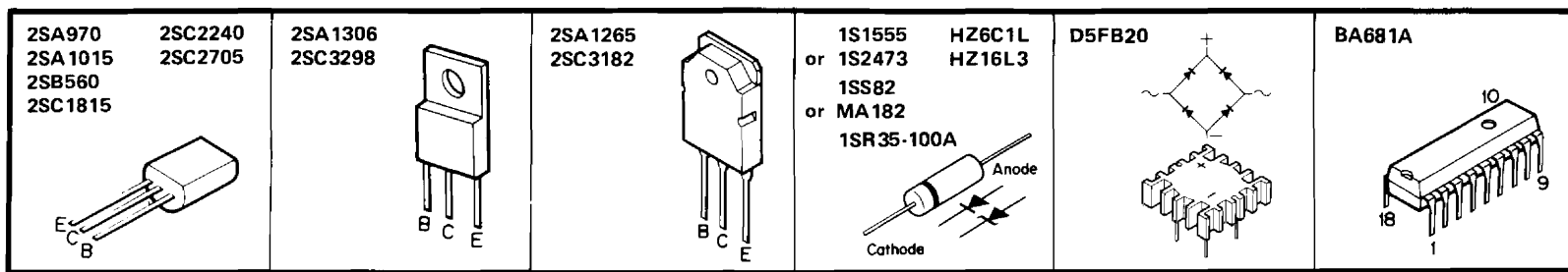

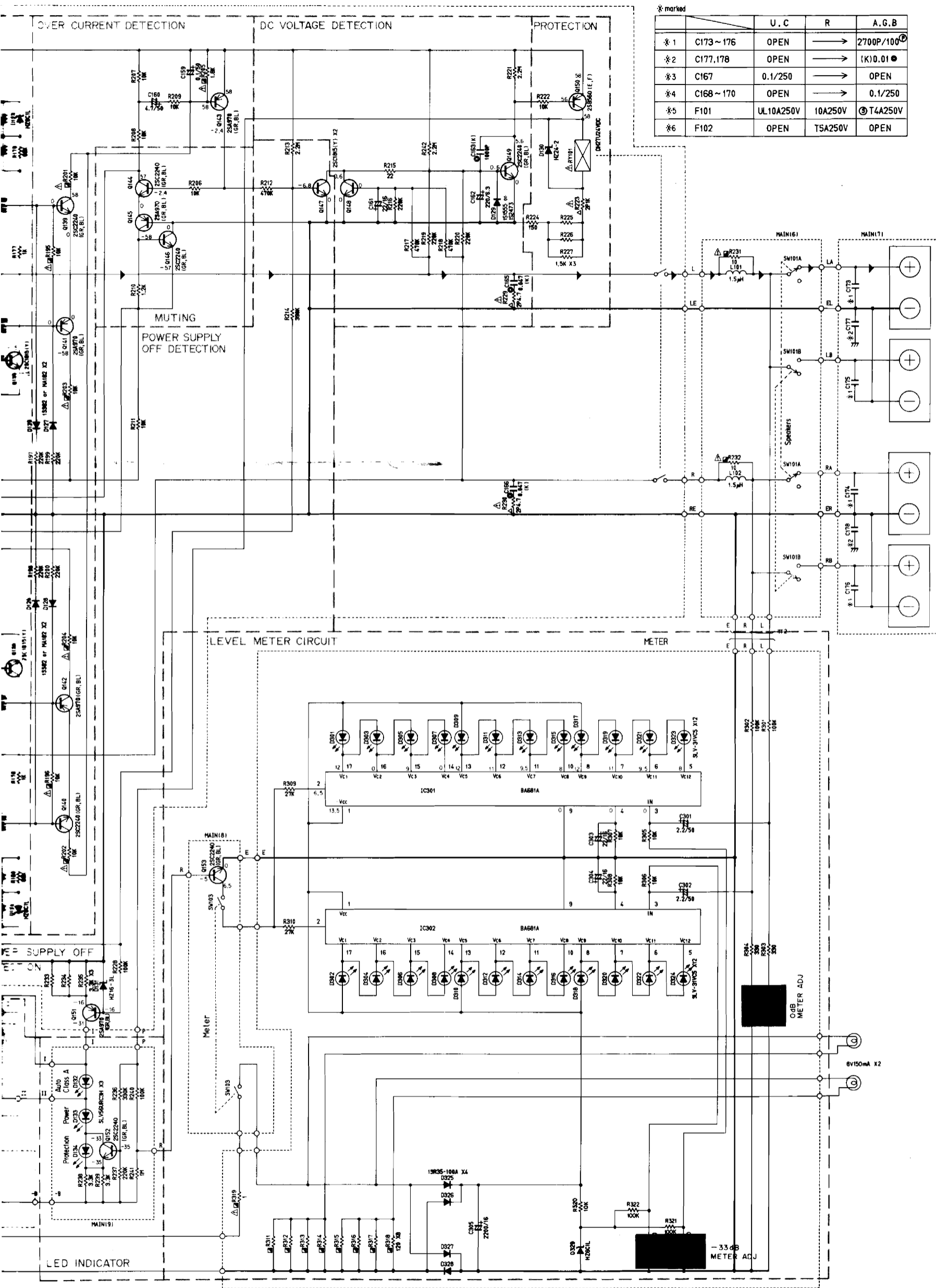

* marked

		U. C	R	A. G. B
*1	C173 ~ 176	OPEN	→	2700P/100 [Ⓢ]
*2	C177, 178	OPEN	→	(K)0.01 ●
*3	C167	0.1/250	→	OPEN
*4	C168 ~ 170	OPEN	→	0.1/250
*5	F101	UL10A250V	→	10A250V [Ⓢ] T4A250V
*6	F102	OPEN	→	T5A250V OPEN

CAPACITOR	
REMARKS	PARTS NAME
NO MARK	ELECTROLYTIC CAPACITOR
NO MARK	CERAMIC CAPACITOR
⊙	POLYESTER FILM CAPACITOR (MYLAR)
○	POLYSTYRENE FILM CAPACITOR
⊖	MICA CAPACITOR
Ⓟ	POLY PROPYLENE FILM CAPACITOR
●	SEMICONDUCTIVE CERAMIC CAPACITOR

RESISTOR	
REMARKS	PARTS NAME
NO MARK	CARBON FILM RESISTOR (1/4W)
△	METAL OXIDE FILM RESISTOR
▲	METAL FILM RESISTOR
⊠	METAL PLATE RESISTOR
⊞	FIRE PROOF CARBON FILM RESISTOR
□	SEMENT MOLDED RESISTOR
⊕	SEMI VARIABLE RESISTOR

CAUTION

● Components having special characteristics are marked △ and must be replaced with parts having specifications equal to those originally installed.

* All voltages are measured with a 10MΩ/V DC electric volt meter.
 * Schematic diagram is subject to change without notice.

■ IC BLOCK DIAGRAM

IC301, 302
BA681A

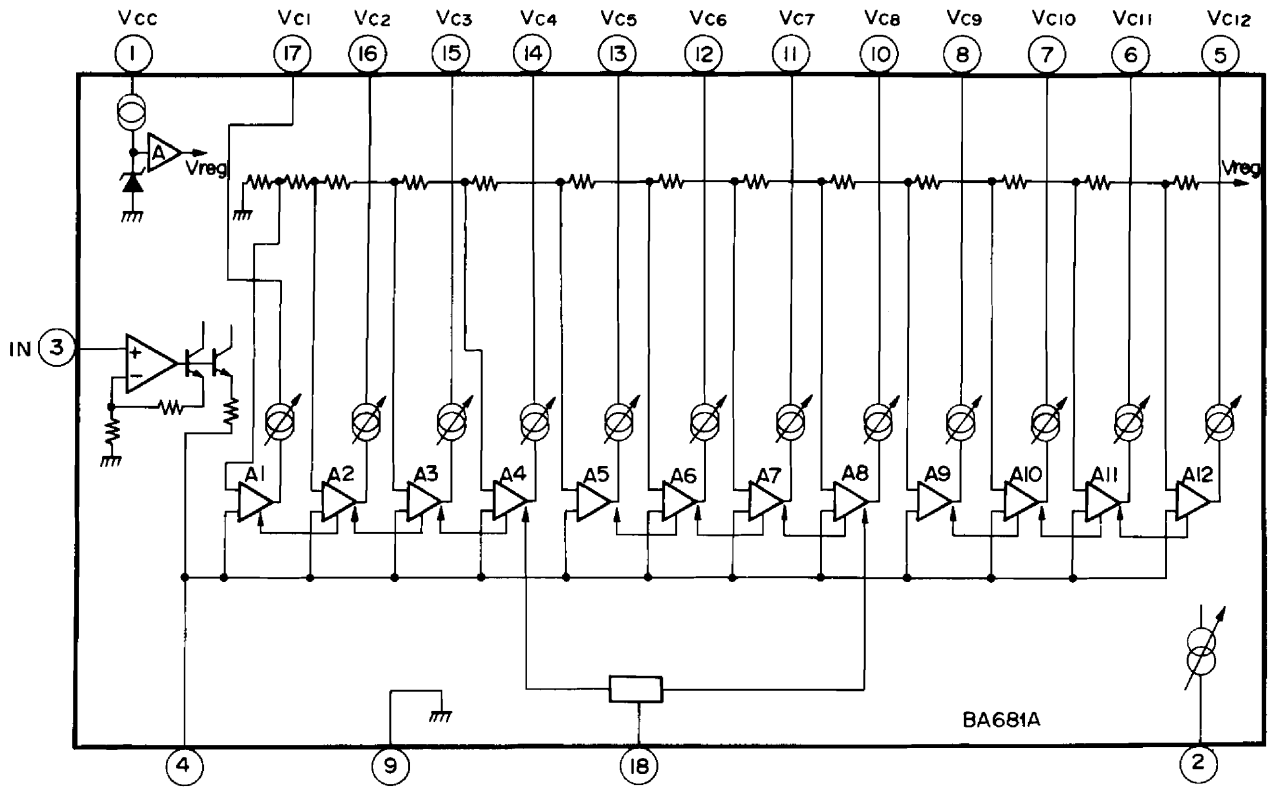
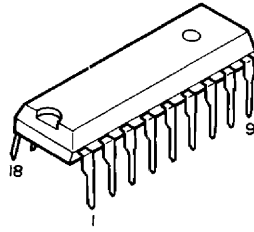

■ WARNING

Components having special characteristics are marked  and must be replaced with parts having specifications equal to those originally installed.
 * Carbon resistors 1/4 W are not included in the ELECTRICAL PARTS list.
 For the parts No. of the carbon resistor, refer to P. 20.

PARTS LIST

■ ELECTRICAL PARTS

Ref. No.	Part No.	Description	部 品 名	Remarks	Common Model	Markets	ランク
*	NA 08 94 40	Main Circuit Board Ass'y	メ イ ン シ ー ト			R	
*	NA 08 94 50	"	"			U	
*	NA 08 94 60	"	"			A,G,B	
*	NA 08 99 80	"	"			C	
	FC 44 31 00	Mylar CaP.	1000P 50V	マ イ ラ ー コ ン	C163		
	FC 34 32 20	"	2200P 50V	"	C121,122		
	FC 44 41 00	"	0.01 μ F 50V	"	C177,178	A,G,B	
	FC 44 44 70	"	0.047 μ F 50V	"	C165,166		
	FI 41 41 00	Ceramic Cap.	0.01 μ F VA-1	セ ラ コ ン	C179	Inter-changeable	
	FI 51 41 00	"	0.01 μ F DNS	"	"		
	FU 35 05 00	FE Mica Cap.	5P 500V	F E マ イ カ コ ン	C125,126		
	FU 35 11 00	"	10P 500V	"	C109,119		
	FU 35 12 00	"	22P 500V	"	C133~136,139~142		
	FZ 00 46 60	Metallized Mylar Cap.	0.1 μ F 250V	M M コ ン	C164		
	FZ 00 46 60	"	0.1 μ F 250V	"	C167	R,U,C	
	FZ 00 46 60	"	0.1 μ F 250V	"	C168~170	A,G,B	
	FZ 00 59 80	"	1000 μ F 80V	オーディオコン(UKJ)	C127,128		
	FZ 00 61 30	Electrolytic Cap.	220 μ F 6.3V	ブラックゲートコン	C107,108		
	FZ 00 63 00	"	47 μ F 16V	"	C103,104		
	UA 25 54 70	Mylar Cap.	0.47 μ F 50V	マ イ ラ ー コ ン	C143,144		
	UH 01 82 20	Electrolytic Cap.	220 μ F 6.3V	ケ ミ コ ン	C162		
	UH 13 72 20	"	22 μ F 16V	"	C161		
	UH 15 74 70	"	47 μ F 35V	"	C129,130,137,138 151~154		
	UJ 16 51 00	"	0.1 μ F 50V	"	C159		
	UH 16 54 70	"	0.47 μ F 50V	"	C157,158		
	UH 16 64 70	"	4.7 μ F 50V	"	C155,156,160		
	UJ 16 71 00	"	10 μ F 50V	"	C150		
	UT 45 44 70	Polypropylene Film Cap.	0.047 μ F 100V	ポ リ プ ロ コ ン	C145~148		
	UT 65 21 00	"	100P 100V	"	C105,106		
	UT 65 22 20	"	220P 100V	"	C101,102,123,124		
	UT 45 21 50	"	150P 100V	"	C131,132		
	UT 65 24 70	"	470P 100V	"	C149		
	UT 46 32 70	"	2700P 100V	"	C173~176	A,G,B	
	HL 32 34 70	Metal Oxide Film Resistor	4.7 Ω 2W	酸 金 抵 抗	R229,230		
	HL 22 61 00	"	1k Ω 2W	"	R223		
*	VA 87 21 00	"	0.22 Ω 3W	"	R155~162		
	HV 45 32 20	Flame Proof Carbon Resistor	2.2 Ω 1/4W	不 燃 化 カ ー ボ ン 抵 抗	R163~167		
	HV 45 34 70	"	4.7 Ω 1/4W	"	R143,144,151~154		
	HV 45 41 00	"	10 Ω 1/4W	"	R231,232		
	HV 45 42 20	"	22 Ω 1/4W	"	R119,120		
	HV 45 44 70	"	47 Ω 1/4W	"	R141,142		
	HV 45 51 00	"	100 Ω 1/4W	"	R149,150		
	HV 45 55 60	"	560 Ω 1/4W	"	R135,136		
	HV 45 58 20	"	820 Ω 1/4W	"	R189,190,245,246		
	HV 45 61 20	"	1.2k Ω 1/4W	"	R145~148		
	HV 45 61 80	"	1.8k Ω 1/4W	"	R205		
	HV 45 62 20	"	2.2k Ω 1/4W	"	R133,134		
	HV 45 64 70	"	4.7k Ω 1/4W	"	R191~194		
	HV 45 71 00	"	10k Ω 1/4W	"	R195,196,201~204		
*	VA 99 40 00	Potentiometer	20k Ω -B	可 変 抵 抗 器	VR101,102		
	HT 37 03 40	Pre-Set Potentiometer	1k Ω -B	半 固 定 抵 抗	VR103,104		

*New Parts (新規部品)

Ref. No.	Part No.	Description	部 品 名		Remarks	Common Model	Markets	ランク
	GD:90:03:40	Coil	1.5 μ H	アウトブットコイル	L101,102			
	iA:09:70:00	Transistor	2SA970(GR,BL)	トランジスタ	Q101~104,111,112,117,118,141~143,145,151			
	iA:10:15:11	//	2SA1015(Y)	//	Q131~134,137,138			
	iA:13:06:40	//	2SA1306	//	Q121,122			
	iB:05:60:00	//	2SB560(E,F)	//	Q150			
	iC:22:40:00	//	2SC2240(GR,BL)	//	Q113~116,139,140,144,146,149,152,153			
	iC:18:15:11	//	2SC1815(Y)	//	Q105~108,135,136,147,148			
	iC:27:05:00	//	2SC2705(O,Y)	//	Q109,110			
	iC:32:98:40	//	2SC3298	//	Q119,120			
	iF:00:06:70	Diode	1S2473	ダイオード	D101~106,129	Inter-changeable		
	iF:00:00:40	//	1S1555	//	//			
	iF:00:55:60	//	1SS82	//	D107~112,125~128,135			
	iF:00:19:40	Zener Diode	HZ24-2	ツェナーダイオード	D130			
	iF:00:15:10	//	HZ6C1L	//	D123,124			
	iF:00:20:80	//	HZ16-3L	//	D131			
	iF:00:44:40	LED(Red)	SLV56URC3H	LED	D132~134			
	iH:00:11:30	Diode	D5FB20	ダイオードブリッジ	D136			
	KA:80:43:00	Power Switch	TV-8	パワースワ	SW104		C	
	KA:80:35:20	Push Switch	SDL TV-5	プッシュスワ	//		R,U,A,G,B	
*	VA:87:19:00	//	2-2SPUF	//	SW103			
*	VA:87:20:00	//	4-2SPUN	//	SW102			
*	VA:87:60:00	//	2-2 2-Ganged	//	SW101			
	KB:00:04:00	Fuse	T5A 250V	ヒューズ	F102		R	△
	KB:00:07:90	//	T4A 250V	//	F101		A,G,B	△
	KB:00:13:90	//	10A 250V	//	//		U,C	△
	KB:00:14:90	//	10A 250V	//	//		R	△
	KC:00:19:40	Relay	DH2TU 24VPC	リレー	RY101			
	LB:20:25:60	Pin Jack	2P	ピンジャック	PJ101			
	LA:00:24:80	Wrapping Terminal	2P P=10	ラッピングタンシバン			U,A,G,C,B	
	LA:00:24:90	//	3P P=10	//			R	
	LA:00:46:80	Terminal	8P	ネジターミナル				
	LB:20:10:60	Fuse Holder	YSH403T	ヒューズホルダー			A,G,B	
	LB:20:19:70	//	23165081	//			R,U,C	
	LB:91:80:80	Base Holder Pin	8P	ベースピン				
	BB:06:83:70	Ground Terminal		アースカナグ				
	BB:07:04:10	Bus Ber	l=55mm	バスバー				
	BB:07:04:30	//	l=145mm	//				
	CA:08:52:60	Spacer		スペーサー	SW102,103		C	
	NA:08:94:70	Meter Circuit Board Ass'y		メーターシート				
	UH:13:72:20	Electrolytic Cap.	22 μ F 16V	ケミコン	C303,304			
	UH:16:62:20	//	2.2 μ F 50V	//	C301,302			
	UJ:13:92:20	//	2200 μ F 16V	//	C305			

*New Parts (新規部品)

MECHANISM EXPLODED VIEW

1

2

3

4

5

6

7

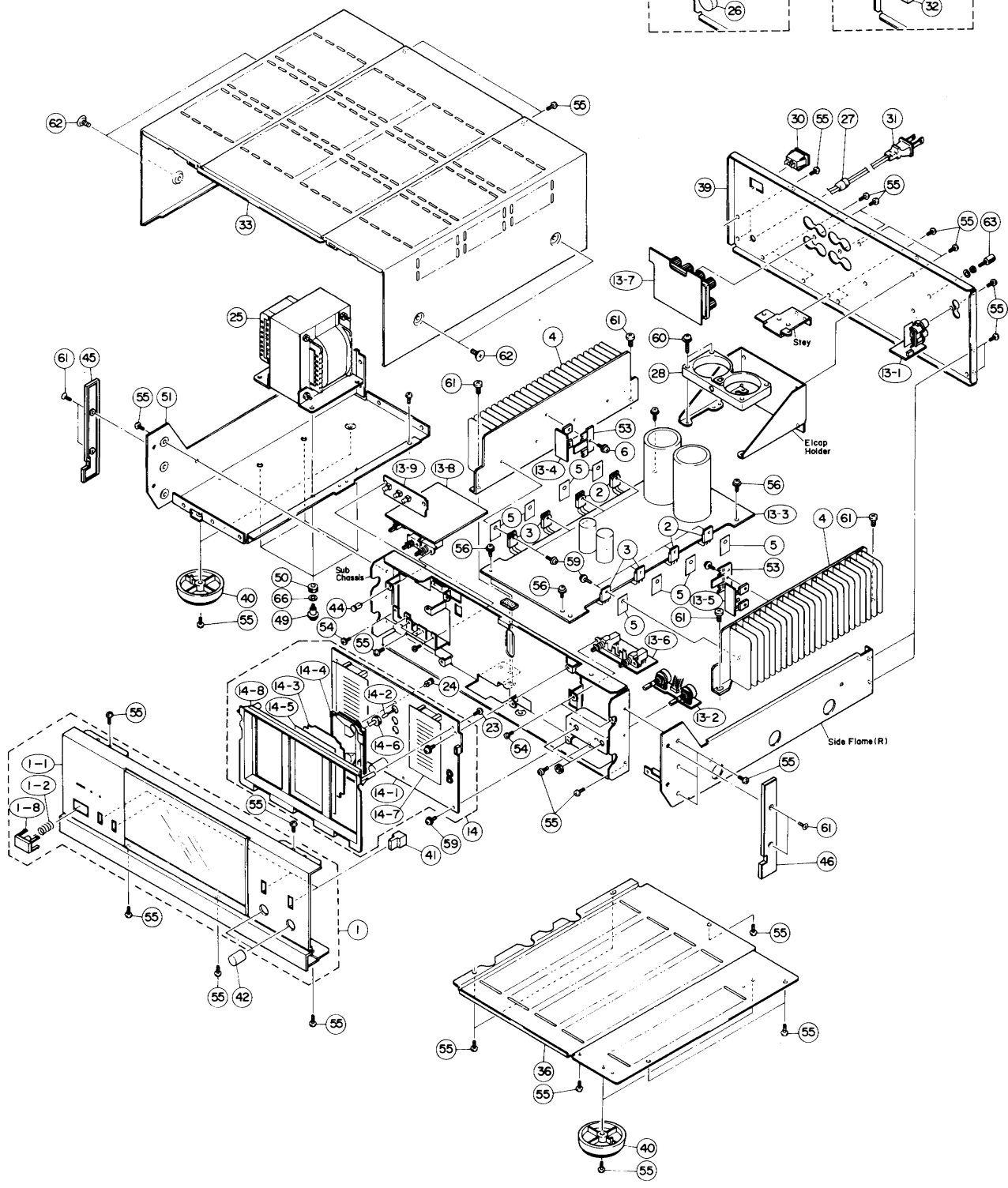
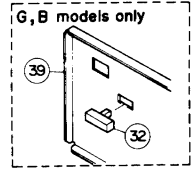
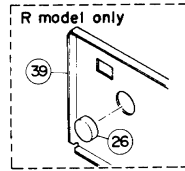

MECHANISM PARTS

Ref. No.	Part No.	Description	部 品 名	Remarks	Common Model	Markets	ランク
* 1	NB 63 26 60	Panel Unit	パネルユニット				
1-2	AA 62 20 80	Spring	スプリング		M-80		
1-3	CB 63 03 50	Push Button	プッシュボタン	POWER	M-80		
2	iA 12 65 30	Transistor	2SA1265	トランジスター	Q127,128,129,130		
3	iC 31 82 30	//	2SC3182	//	Q123,124,125,126		
* 4	BA 09 43 00	Radiator	ラジエータ				
* 5	VB 43 50 00	Radiation Sheet	放熱ベース				
6	EK 33 00 20	BW Head Tapping Screw	3×14 ZMC 2-BI	BWヘッドタッピンネジ			
13	NA 08 94 40	Main Circuit Board Ass'y		メインシート		R	
//	NA 08 94 50	//		//		U,C	
//	NA 08 94 60	//		//		A,G,B	
* //	NA 08 99 80	//		//		C	
14	NB 63 26 90	Meter Unit		メーターユニット			
14-1	NA 08 94 70	Meter Circuit Board Ass'y		メーターシート			
14-2	JB 00 11 00	Pilot Lamp	8V 150mA	パイロットランプ			
14-3	CB 63 05 30	Lamp Reflector		ランプリフレクター	M-80		
14-4	CB 63 05 50	Diffusion Plate		拡散プレート	M-80		
* 14-5	CB 65 11 70	Meter Sheet		メーターシート			
14-6	CB 63 07 50	Lamp Cap.		ランプキャップ	M-80		
14-7	CB 65 11 80	Diffusion Film		拡散フィルム			
14-8	CB 63 02 90	Meter Cover		メーターカバー	M-80		
23	Ei 33 01 06	Binding Head Tapping Screw	ZMC 2-BL 3×10	バインドタッピン			
24	CB 06 88 80	Plastic Rivet		プラスチックリベット			
* 25	XA 57 80 01	Power Transformer		電源トランス		U	△
* //	XA 57 90 01	//		//		A	△
* //	XA 58 00 01	//		//		G,B	△
* //	XA 58 10 01	//		//		C	△
* //	XA 57 70 01	//		//		R	△
26	LB 20 14 80	Voltage Selector	0211	電圧切換器		R	△
	CB 06 92 50	Binding Tie	BK-1	インシュロックタイ			
27	CB 62 02 00	Cord Stopper	CM-22C	コードストッパー		U,C	
//	CB 62 01 90	//	CM-22B	//		R,A,G,B	
28	FZ 00 62 50	Electrolitic Cap.	22000 μ F 69V	ケミコン a pair			
29	LA 00 29 50	2P Relay Terminal	MA0092A	2P中継端子台		A,G,B	
30	LB 20 18 10	AC OUTLET	S-i6498	ACアウトレット		R	△
//	LB 20 30 60	//		//		U,C	△
* 31	MG 00 23 40	Power Cord	6A250V 2m	電源コード	} Inter-changeable	R	△
//	MG 00 16 30	//	6A250V 2m	//		R	△
* //	MG 00 22 20	//	10A125V 1.98m	//	} Inter-changeable	U,C	△
* //	MG 00 23 10	//	7.5A250V 2.5m	//		A	△
* //	MG 00 09 20	//	7.5A250V 2.5m	//		A	△
* //	MG 00 14 90	//	7.5A250V 2.5m	//		A	△
* //	MG 00 16 20	//	2.5A250V 2m	//		G,B	△
32	KA 40 12 60	Slide Switch	SS-12 5A/40A	スライドSW		G,B	△
33	AA 62 19 80	Top Cover		トップカバー	M-80		
36	AA 62 20 30	Bottom Cover		ボトムカバー	M-80		
* 39	AA 62 91 00	Rear Panel		リアパネル		R	
* //	AA 62 91 10	//		//		U,C	
* //	AA 62 91 20	//		//		G,B	
* //	AA 62 91 30	//		//		A	
40	NB 62 03 20	Leg Ass'y		レッグ Ass'y	M-80		
41	NB 62 04 60	Button Ass'y		ボタン Ass'y	M-80		

*New Parts (新規部品)

Parts List for Carbon Resistor

Value	1/4W Type Part No.	1/6W Type Part No.	Value	1/4W Type Part No.	1/6W Type Part No.
1.0 Ω	HJ353100	*	12K Ω	HJ357120	HF857120
1.8 "	HJ353180	*	15 "	HJ357150	HF857150
2.2 "	HJ353220	HF853220	18 "	HJ357180	HF857180
3.3 "	HJ353330	HF853330	22 "	HJ357220	HF857220
4.7 "	HJ353470	HF853470	27 "	HJ357270	HF857270
5.6 "	HJ353560	HF853560	33 "	HJ357330	HF857330
10 "	HJ354100	HF854100	39 "	HJ357390	HF857390
15 "	HJ354150	HF854150	47 "	HJ357470	HF857470
22 "	HJ354220	HF854220	56 "	HJ357560	HF857560
27 "	HJ354270	HF854270	68 "	HJ357680	HF857680
33 "	HJ354330	HF854330	82 "	HJ357820	HF857820
39 "	HJ354390	HF854390	91 "	HJ357910	HF857910
47 "	HJ354470	HF854470	100 "	HJ358100	HF858100
56 "	HJ354560	HF854560	120 "	HJ358120	HF858120
68 "	HJ354680	HF854680	150 "	HJ358150	HF858150
82 "	HJ354820	HF854820	180 "	HJ358180	HF858180
100 "	HJ355100	HF855100	220 "	HJ358220	HF858220
110 "	HJ355110	HF855110	270 "	HJ358270	HF858270
120 "	HJ355120	HF855120	330 "	HJ358330	HF858330
150 "	HJ355150	HF855150	390 "	HJ358390	HF858390
160 "	HJ355160	*	470 "	HJ358470	HF858470
180 "	HJ355180	HF855180	560 "	HJ358560	HF858560
220 "	HJ355220	HF855220	680 "	HJ358680	HF858680
270 "	HJ355270	HF855270	820 "	HJ358820	HF858820
330 "	HJ355330	HF855330	1.0M Ω	HJ359100	HF859100
390 "	HJ355390	HF855390	1.2 "	HJ359120	*
470 "	HJ355470	HF855470	1.5 "	HJ359150	HF859150
510 "	*	HF855510	1.8 "	HJ359180	HF859180
560 "	HJ355560	HF855560	2.2 "	HJ359220	HF859220
680 "	HJ355680	HF855680	3.3 "	HJ359330	HF859330
820 "	HJ355820	HF855820	3.9 "	HJ359390	*
910 "	HJ355910	HF855910	4.7 "	HJ359470	*
1.0K Ω	HJ356100	HF856100			
1.2 "	HJ356120	HF856120			
1.5 "	HJ356150	HF856150			
1.8 "	HJ356180	HF856180			
2.0 "	HJ356200	HF856200			
2.2 "	HJ356220	HF856220			
2.4 "	HJ356240	HF856240			
2.7 "	HJ356270	HF856270			
3.0 "	HJ356300	HF856300			
3.3 "	HJ356330	HF856330			
3.6 "	HJ356360	HF856360			
3.9 "	HJ356390	HF856390			
4.7 "	HJ356470	HF856470			
5.1 "	HJ356510	HF856510			
5.6 "	HJ356560	HF856560			
6.8 "	HJ356680	HF856680			
8.2 "	HJ356820	HF856820			
9.1 "	HJ356910	HF856910			
10 "	HJ357100	HF857100			

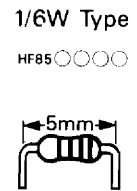
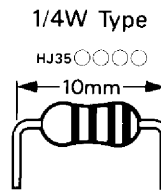

STEREO POWER AMPLIFIER

M-45

SERVICE MANUAL

CORRECTIONS

- There are additions to and mistakes in the voltages in the M-45 circuit diagram, which should be corrected.
- This is the correct circuit diagram for the M-45. Disregard the previous circuit diagram M-45 (100029) printed in the service manual.

1. ADDITIONAL VOLTAGES (Power source section)

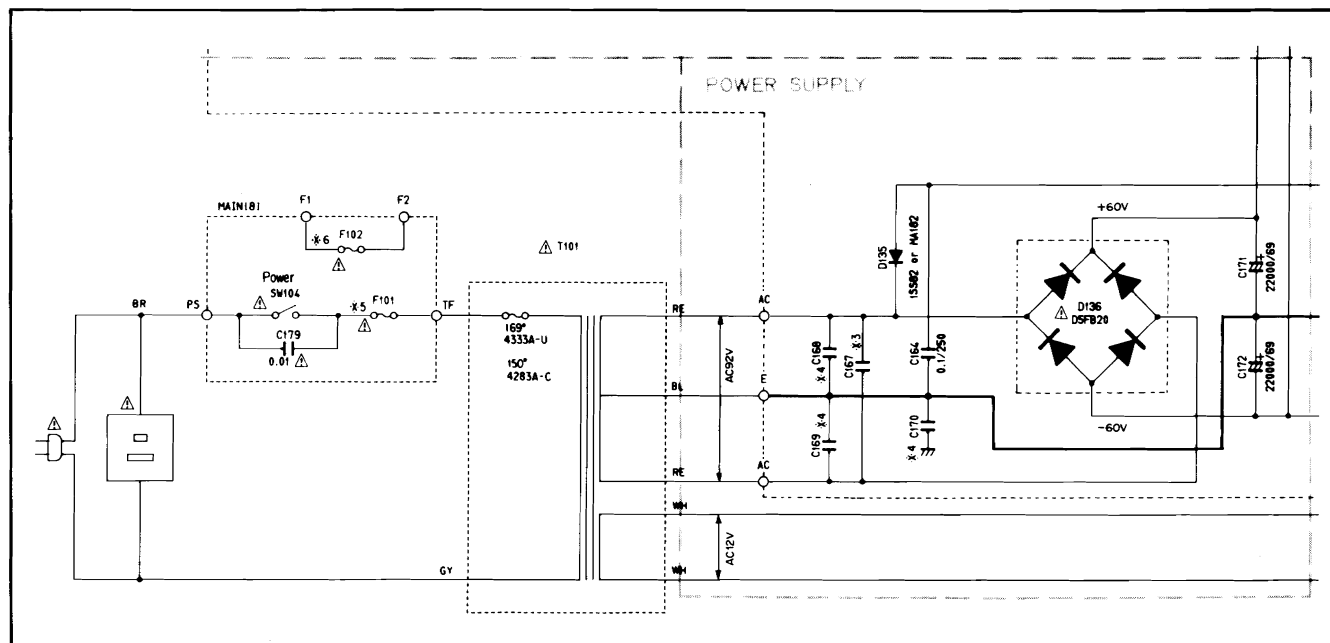

2. CORRECTING VOLTAGES (V-AMP and I-AMP sections)

- Wrong voltage

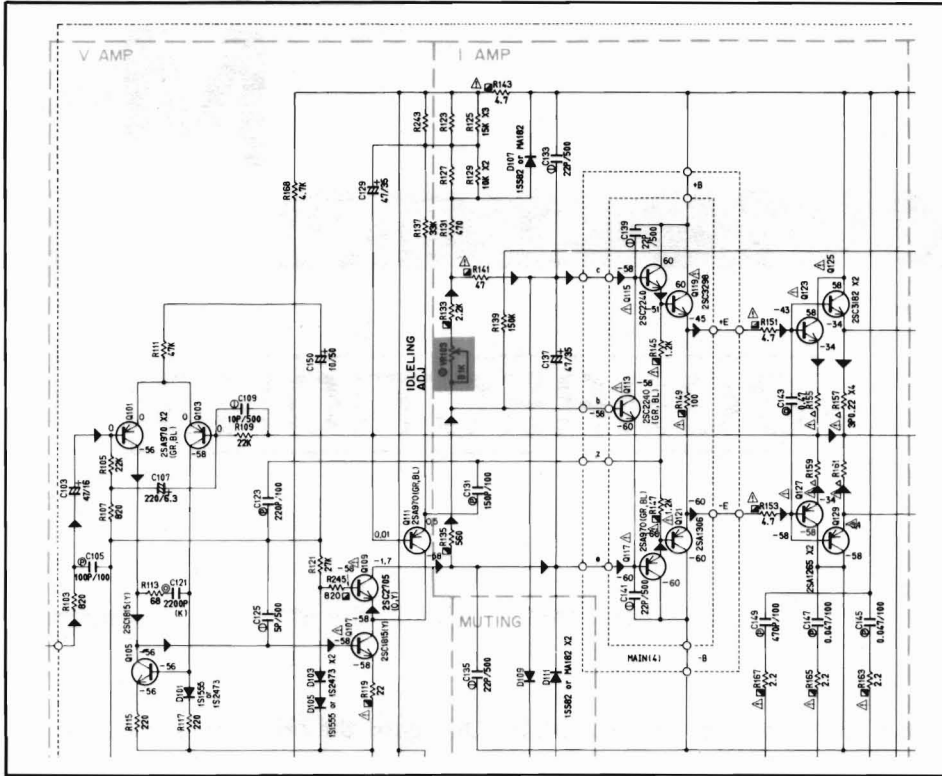

- Correct voltage

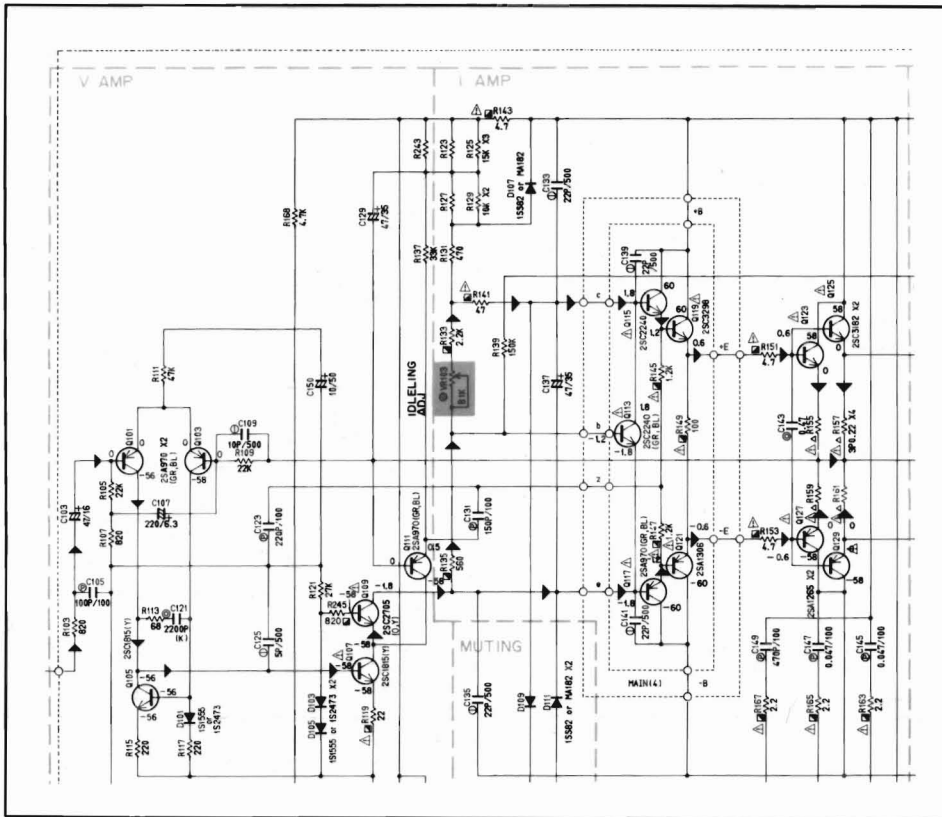

- Table of errata

	Q109			Q111			Q113			Q115			Q117			Q119			Q121			Q123			Q125			Q127			Q129		
	E	C	B	E	C	B	E	C	B	E	C	B	E	C	B	E	C	B	E	C	B	E	C	B	E	C	B	E	C	B			
Wrong voltage	-58	-1.7	-58	0.5	-58	0.01	-60	-58	-58	-51	60	-58	-60	-60	-45	60	-51	-60	-60	-60	-34	58	-45	-34	58	-45	-34	-58	-58	-34	-58	-58	
Correct voltage	-58	-1.8	-58	0.5	-58	0	-1.8	1.8	-1.2	1.2	60	1.8	-1.2	-60	-1.8	0.6	60	1.2	-0.6	-60	-1.2	0	58	0.6	0	58	0.6	0	-58	-0.6	0	-58	-0.6

SCHEMATIC DIAGRAM

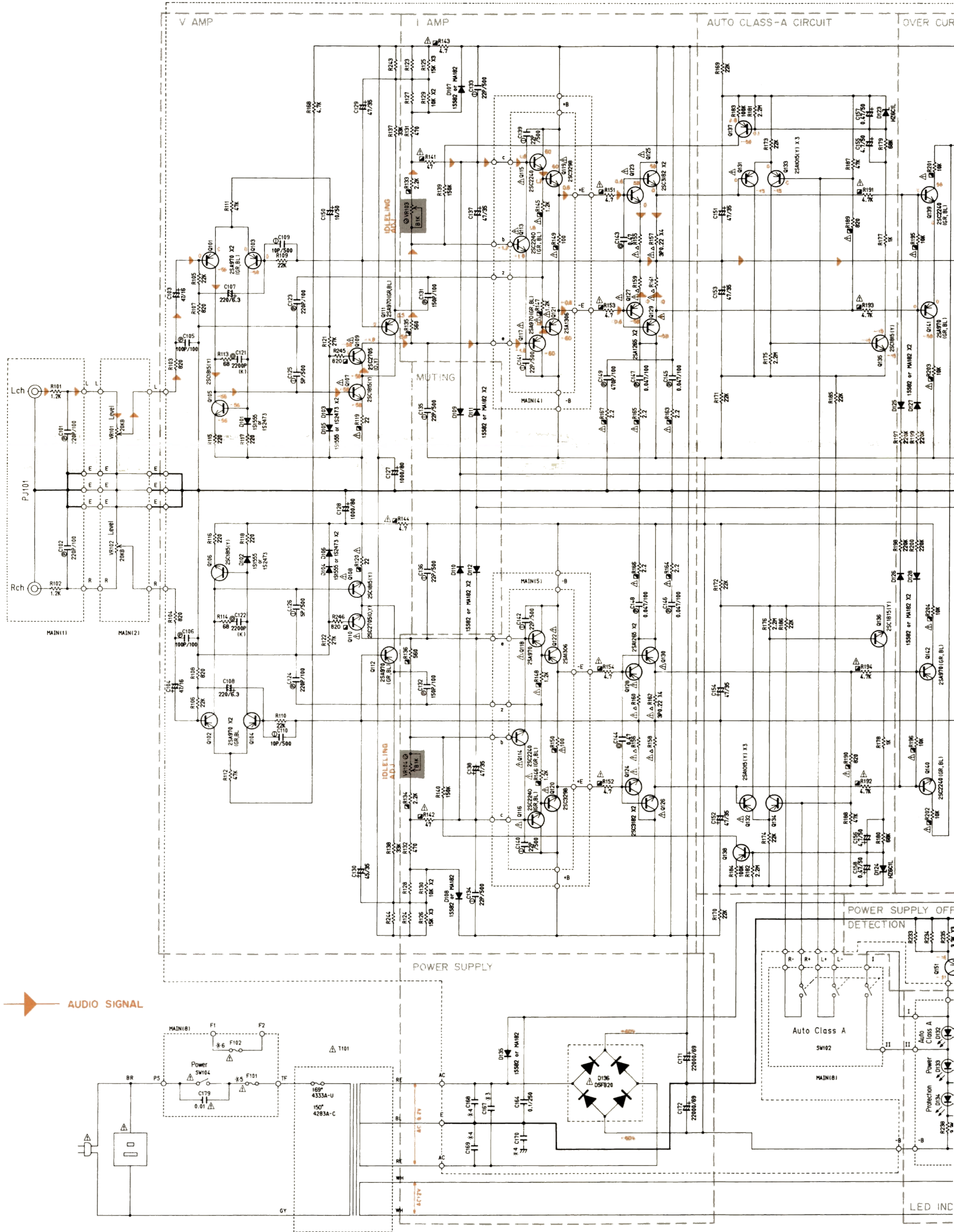

PIN CONNECTION DIAGRAM OF TRANSISTORS, DIODE AND ICS.

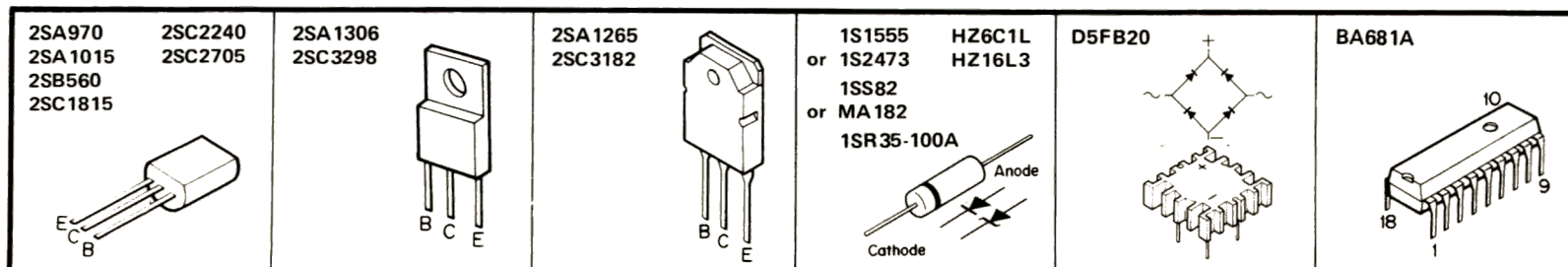

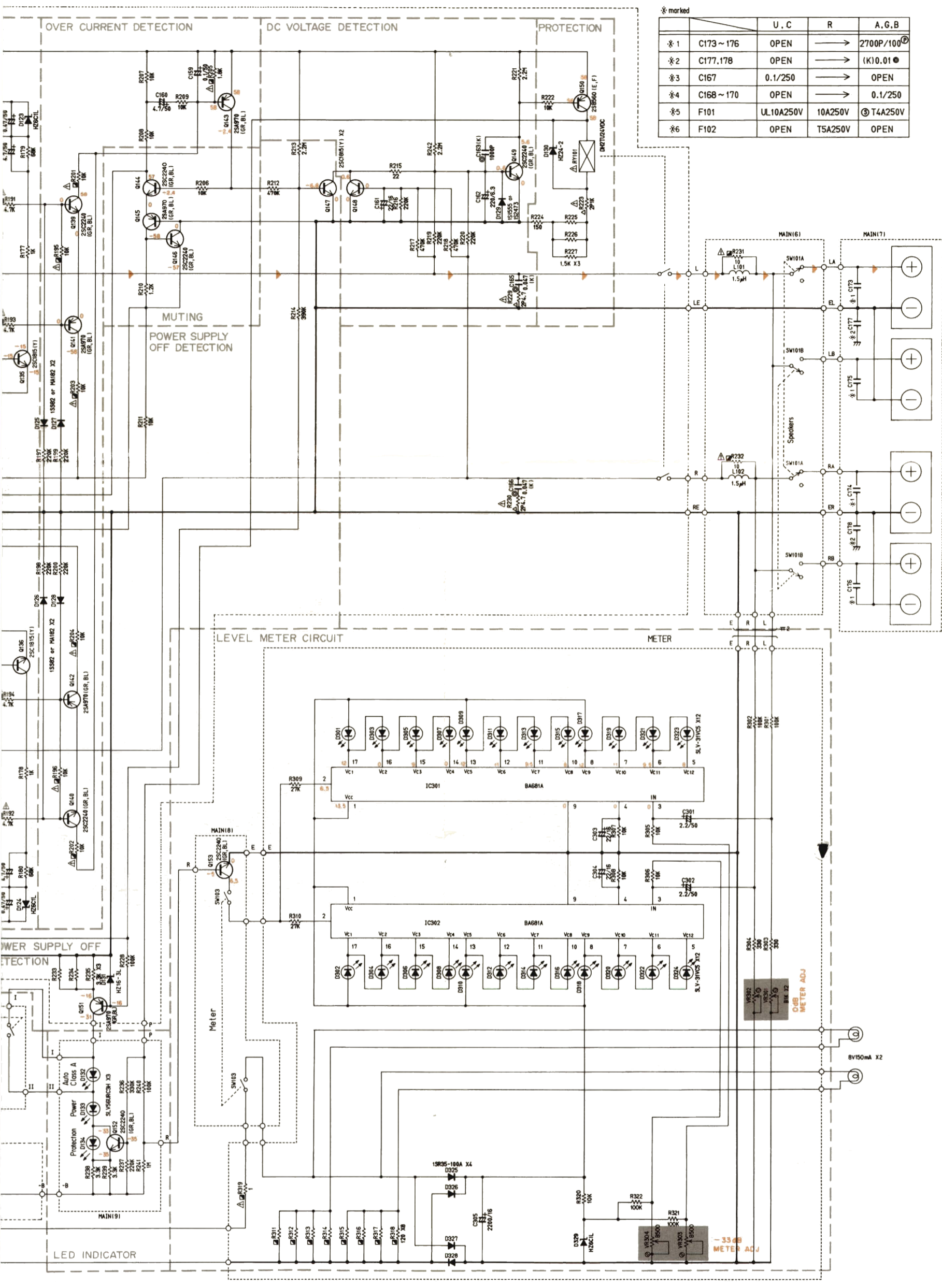

* marked

		U. C	R	A. G. B
*1	C173 ~ 176	OPEN	→	2700P/100 [Ⓢ]
*2	C177, 178	OPEN	→	(K)0.01 ●
*3	C167	0.1/250	→	OPEN
*4	C168 ~ 170	OPEN	→	0.1/250
*5	F101	UL10A250V	→	10A250V Ⓢ T4A250V
*6	F102	OPEN	→	T5A250V OPEN

CAPACITOR

REMARKS	PARTS NAME	
NO MARK	ELECTROLYTIC CAPACITOR	⊥
NO MARK	CERAMIC CAPACITOR	
⊙	POLYESTER FILM CAPACITOR (MYLAR)	
○	POLYSTYRENE FILM CAPACITOR	
○	MICA CAPACITOR	
Ⓢ	POLY PROPYLENE FILM CAPACITOR	
●	SEMICONDUCTIVE CERAMIC CAPACITOR	

RESISTOR

REMARKS	PARTS NAME	
NO MARK	CARBON FILM RESISTOR (1/4W)	
△	METAL OXIDE FILM RESISTOR	
▲	METAL FILM RESISTOR	
⊠	METAL PLATE RESISTOR	
⊠	FIRE PROOF CARBON FILM RESISTOR	
□	SEMENT MOLDED RESISTOR	
⊕	SEMI VARIABLE RESISTOR	

CAUTION

- Components having special characteristics are marked \triangle and must be replaced with parts having specifications equal to those originally installed.
- * All voltages are measured with a 10M Ω /V DC electric volt meter.
- * Schematic diagram is subject to change without notice.